

Beosound A1 2nd Gen

Quick Start Guide

Lynguide

Kurzanleitung

Guía de inicio rápido

Guide de démarrage rapide

Guida di avvio rapido

クイックスタートガイド

빠른 시작 가이드

Snelstartgids

Guia de início rápido

Краткое руководство пользователя

Snabbstartguide

快速入门指南

快速入門指南



1

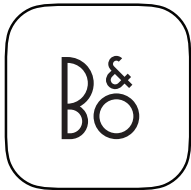

Bang & Olufsen



Bang-Olufsen.com/APP

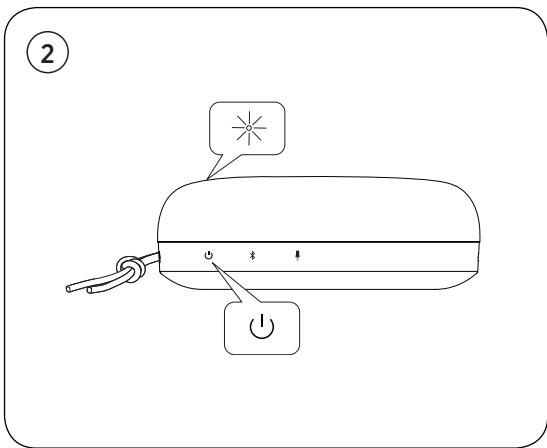

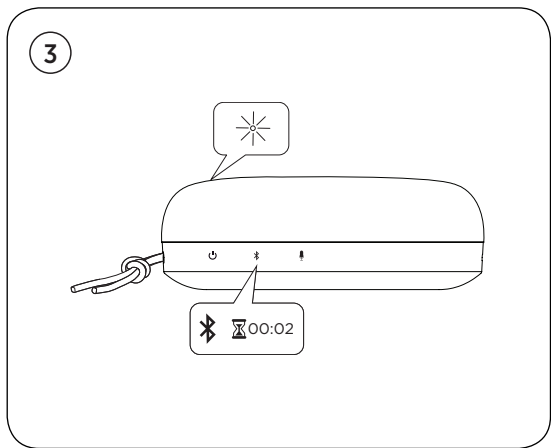

4

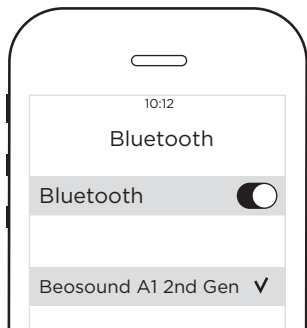

- EN** You can set up Amazon Alexa via the Bang & Olufsen App.
- DA** Det er muligt, at opsætte Amazon Alexa via appen Bang & Olufsen.
- DE** Amazon Alexa lässt sich über die Bang & Olufsen App einrichten.
- ES** Puede configurar Amazon Alexa a través de la aplicación Bang & Olufsen.
- FR** Vous pouvez configurer Amazon Alexa via l'application Bang & Olufsen.
- IT** È possibile configurare Amazon Alexa tramite l'app Bang & Olufsen.
- JA** Amazon Alexa を Bang & Olufsen アプリを使用してセットアップできます。
- KO** Bang & Olufsen 앱을 통해 Amazon Alexa를 설정할 수 있습니다.

- NL** U kunt Amazon Alexa instellen met de Bang & Olufsen-app.
- PT** Pode instalar a Amazon Alexa através da aplicação Bang & Olufsen.
- RU** Вы можете настроить Amazon Alexa через приложение Bang & Olufsen.
- SV** Du kan ställa in Amazon Alexa via Bang & Olufsen-appen.
- ZH** 通过应用 Bang & Olufsen 可设置亚马逊的个人助理 Alexa。
- ZHTW** 您可以透過 Bang & Olufsen 應用程式來設定 Amazon Alexa。
- AR** يمكنك تثبيت Amazon Alexa من خلال تطبيق Bang & Olufsen.

TILMELD DIG ONLINE
REGISTRIEREN SIE SICH ONLINE
REGISTER ONLINE
REGISTRO EN LÍNEA
INSCRIPTION EN LIGNE
REGISTRAZIONE ON-LINE
オンライン登録
온라인 등록
ONLINE REGISTREREN
REGISTO ONLINE
ОНЛАЙН РЕГИСТРАЦИЯ
ONLINE-REGISTRERING
在线注册
線上註冊

Tilmeld dig online på www.bang-olufsen.com/register-product for at modtage vigtige oplysninger om produkt- og softwareopdateringer fra BANG & OLUFSEN Group. Hvis du har købt dit produkt i en BANG & OLUFSEN-butik eller på www.bang-olufsen.com, er du automatisk blevet tilmeldt.

DA

Registrieren Sie sich online unter www.bang-olufsen.com/register-product, um wichtige Informationen zu Produkt- und Software-Aktualisierungen sowie interessante Neuigkeiten und Angebote von der BANG & OLUFSEN Gruppe zu erhalten. Wenn Sie ein Produkt in einem BANG & OLUFSEN Fachgeschäft oder auf www.bang-olufsen.com gekauft haben, sind Sie bereits registriert.

DE

Register online at www.bang-olufsen.com/register-product to receive important information about product and software updates – and to get exciting news and offers from the BANG & OLUFSEN Group. If you have purchased your product at a BANG & OLUFSEN store or at www.bang-olufsen.com, you have automatically been registered.

EN

Regístrese online en la página web www.bang-olufsen.com/register-product para recibir información importante acerca del productos y de actualizaciones de software – y para conseguir fantásticas noticias y ofertas del Grupo BANG & OLUFSEN. Si ha adquirido el equipo en una tienda BANG & OLUFSEN o en www.bang-olufsen.com, se habrá registrado automáticamente.

ES

- FR** Inscrivez-vous en ligne sur www.bang-olufsen.com/register-product pour recevoir des informations importantes sur les mises à jour de produits et de logiciels - et pour obtenir des nouvelles et des offres intéressantes du Groupe BANG & OLUFSEN. Si vous avez acheté votre produit dans un magasin BANG & OLUFSEN ou sur www.bang-olufsen.com, vous avez été inscrit automatiquement.
- IT** Registrarsi online su www.bang-olufsen.com/register-product per ricevere importanti informazioni su prodotti e aggiornamenti software, notizie e le fantastiche offerte del Gruppo BANG & OLUFSEN. Se hai acquistato il tuo prodotto in un punto vendita BANG & OLUFSEN o su www.bang-olufsen.com, la registrazione è automatica.
- JA** www.bang-olufsen.com/register-product にご登録されれば、製品とソフトウェアの更新に関する重要な情報についてお知らせいたします。さらには BANG & OLUFSEN Group からのホットなニュースやオファーもご利用になれます。BANG & OLUFSEN ストアまたは www.bang-olufsen.com にて商品をご購入されたお客様はすでに登録済です。
- KO** 제품 및 소프트웨어에 관한 중요 정보를 수신하고 BANG & OLUFSEN 그룹으로 뉴스와 특별 혜택 소식을 받아보려면 www.bang-olufsen.com/register-product에서 온라인으로 등록하십시오. BANG & OLUFSEN 대리점 또는 www.bang-olufsen.com에서 제품을 구입하신 고객은 자동으로 등록됩니다.

Registreer online op www.bang-olufsen.com/register-product om belangrijke informatie te ontvangen over product- en software-updates - en om de laatste nieuwtjes en aanbiedingen van de BANG & OLUFSEN Group te ontvangen. Als u uw product in een BANG & OLUFSEN-winkel of op www.bang-olufsen.com hebt gekocht, bent u automatisch geregistreerd.

NL

Registe-se online em www.bang-olufsen.com/register-product para receber informações importantes sobre atualizações de produtos e software, e para receber notícias e ofertas entusiasmantes do Grupo BANG & OLUFSEN. Se adquiriu o seu produto numa loja BANG & OLUFSEN ou em www.bang-olufsen.com, foi automaticamente registado.

PT

Зарегистрируйтесь на сайте www.bang-olufsen.com/register-product для получения важной информации о продукции и доступных обновлениях программного обеспечения, новостей и выгодных предложений группы BANG & OLUFSEN. Если вы приобрели свой продукт в магазине BANG & OLUFSEN или на сайте www.bang-olufsen.com, то вы были зарегистрированы автоматически.

RU

Registrera dig online på www.bang-olufsen.com/register-product för att få viktig information om produkter och programuppdateringar samt för att få spännande nyheter och erbjudanden från BANG & OLUFSEN Group. Om du har köpt din produkt i en BANG & OLUFSEN-affär eller hos www.bang-olufsen.com behöver du inte registrera dig, eftersom registreringen redan har utförts automatiskt.

SV

HZ

在线注册www.bang-olufsen.com/register-product，以接收有关产品和软件更新的重要信息，以及获得BANG & OLUFSEN Group令人兴奋的新闻与优惠。如果您从 BANG & OLUFSEN 商店或 www.bang-olufsen.com 购入产品，即已自动注册。

ZHTW

請上 www.bang-olufsen.com/register-product 註冊，以取得有關產品與軟體更新的重要資訊 — 以及獲得來自 BANG & OLUFSEN 集團的重要新聞與優惠。如果您的產品是在 BANG & OLUFSEN 店面或 www.bang-olufsen.com 購買、即已自動獲得註冊。

on.beo.com/beosound-A1-support

online stores hosted in the People's Republic of China or legally imported in connection with an end-user's properly documented relocation to the People's Republic of China. Bang & Olufsen Products purchased in Hong Kong, Macau or Taiwan or elsewhere outside the People's Republic of China are excluded from the Warranty but subject to the applicable legislation in the relevant market of purchase. Import, sale and use of specific Bang & Olufsen Products in the People's Republic of China is subject to China Compulsory Certification (CCC), obtained from the above mentioned authorized stores located or hosted in the People's Republic of China at the time of purchase or upon appropriate documentation of relocation to the People's Republic of China for Bang & Olufsen Products purchased abroad.

For Hong Kong and Macau markets only: The Warranty only applies to Bang & Olufsen Products imported by Bang & Olufsen Limited and purchased from authorized physical stores located or authorized online stores hosted in Hong Kong or Macau, or legally imported in connection with an end-user's properly documented relocation to Hong Kong or Macau. Bang & Olufsen Products purchased outside Hong Kong or Macau are excluded from the Warranty but subject to the applicable legislation in the relevant market of purchase.

otherwise, on behalf of Bang & Olufsen regarding the Bang & Olufsen Products or this Warranty.

Severability

If any portion of this Warranty is held to be illegal or unenforceable, such partial illegality or unenforceability shall not affect the enforceability of the remainder of the Warranty.

Consumer's legal rights

This Warranty is provided in addition to the rights and remedies granted by the seller of the Bang & Olufsen Product or granted under applicable legislation. Any and all remedies (e.g. rectification, claim for damages, and/or right to terminate the contract) granted by the seller of the Bang & Olufsen Product or available by law remain unaffected by this Warranty.

For the Australian market only: Bang & Olufsen Products are subject to the guarantees provided under the Australian Consumer Law. You are entitled to a replacement or refund for a 'major problem' and for compensation for any other reasonably foreseeable loss or damage. You are also entitled to have the Bang & Olufsen Product repaired or replaced if the Bang & Olufsen Product fails to be of acceptable quality and the problem does not amount to a 'major problem';

For the US market only: Some states do not allow the exclusion or limitation of incidental or consequential damages. Thus, the above limitations or exclusions may not apply to you. This Warranty gives you specific legal rights, and you may also have other rights which vary from state to state.

For the People's Republic of China market only: The Warranty only applies to Bang & Olufsen Products imported by Bang & Olufsen Enterprise Management (Shanghai) Co. Ltd. and purchased from Authorised Resellers selling from physical stores located or authorized

country, this Warranty does not apply. To obtain information about usage of the Bang & Olufsen Product in several countries, please contact the legal entity stated on the original invoice for the Bang & Olufsen Product.

All implied warranties, including without limitation, implied warranties of merchantability and fitness for a particular purpose, are limited to the duration of this Warranty. In no event shall Bang & Olufsen be liable for damages in excess of the purchase price of the Bang & Olufsen Product or for, without limitation, commercial loss of any sort; loss of use, time, data, reputation, opportunity, goodwill, profits or savings; inconvenience; incidental, special, consequential or punitive damages; or damages arising from the use or inability to use the Bang & Olufsen Product.

Bang & Olufsen makes no warranties or representations, express or implied, statutory or otherwise, as to the quality, capabilities, operations, performance or suitability of any third-party software or equipment used in conjunction with the Bang & Olufsen Product, or the ability to integrate any such software or equipment with the Bang & Olufsen Product, whether such third-party software or equipment is included with the Bang & Olufsen Product distributed by Bang & Olufsen or otherwise. Responsibility for the quality, capabilities, operations, performance and suitability of any such third-party software or equipment rests solely with the user and the direct vendor, owner or supplier of such third-party software or equipment. Nothing contained in the user manual or any other document shall be construed to create an express warranty of any kind with respect to the Bang & Olufsen Product. No agent, employee, dealer, representative or reseller is authorized to modify or extend this Warranty or to make binding representations or claims, whether in advertising, presentations or

- Unreasonable costs or expenses related to modifications or demolitions of the space in which the Bang & Olufsen Product is placed during the process of repair; and/or
 - Costs for cleaning the screen due to external influences.
- Defects claimed under the Warranty are rectified at Bang & Olufsen's discretion within the rules of the marketing and consumer law.
- Rectification is ensured by way of (i) repairing the defective Bang & Olufsen Product, (ii) inserting remanufactured parts into the Bang & Olufsen Product, and/or (iii) replacing the Bang & Olufsen Product with a new product equivalent in performance and reliability to the Bang & Olufsen Product. Replacement of limited or special edition Bang & Olufsen Products depends on the availability of the Bang & Olufsen Products in question. Where the Bang & Olufsen Product cannot be repaired (damage is considered as total loss) and where exchange is not feasible, compensation is offered on a pro-rata basis of the purchase price.

Exclusions and limitations

Bang & Olufsen is not liable for the damage or loss of any programs, data and/or media content during the repair process. Bang & Olufsen strongly recommends customers to ensure that, if possible, all data is backed up prior to requesting repair services from Bang & Olufsen. The Warranty will not operate if the serial number has been defaced or altered or if non-authorized modifications in the software have been made.

In countries with governmental requirements on specifically developed versions of Bang & Olufsen products, e.g. due to varying transmission systems and approval demands, and the defect or malfunction is caused by the usage of other versions than required in the specific

- Defects which have been caused by wrongful use, incorrect and/or unauthorized installation, incorrect repairs/modifications, or maladjustment of the Bang & Olufsen Product, or neglect, including but not limited to "burn in" of plasma or OLED displays, overdriving of speakers and similar wrongful use;
- Defects resulting from usage of the Bang & Olufsen Product in conjunction with accessories that are not approved by Bang & Olufsen;
- Defects which have been caused by lightning, fire, water, voltage fluctuations, improper ventilation or other events of force majeure beyond the control of Bang & Olufsen;
- Consequential damage, indirect or direct loss or any related expenses claimed under the Warranty, such as but not limited to loss from inability to operate the Bang & Olufsen Product or costs connected with rent of substitution products;
- Software and content provided by third parties or problems occurring due to modifications made by the software provider;
- Field assistance for problems that can be solved with online software updates. It is the customer's responsibility to provide network connection for these updates;
- Problems occurring with network/wireless connection caused by external effects present locally only and not impacting functionality in other locations not experiencing such external effects. To obtain information about the functionality of specific purposes, please contact Bang & Olufsen;
- Defects in consumables (i.e. components that are expected to require regular replacement such as but not limited to batteries) as well as defects caused by overcharging;

General Conditions

Genuine Bang & Olufsen products ("Bang & Olufsen Products") are covered by this limited warranty (the "Warranty"). The terms of this Warranty apply to Bang & Olufsen Products purchased in or after November 2019. To claim any rights under this Warranty, the original invoice received at the time of purchase of the Bang & Olufsen Product must be presented to Bang & Olufsen. This Warranty covers all defects (relevant to the specification of the Bang & Olufsen Product in question) that may arise in the Bang & Olufsen Product within the warranty period. The warranty period commences upon the date of purchase by the first consumer purchaser and continues for the following 24 months after that date (the "Warranty Period").

If a defect covered by the Warranty arises within the Warranty Period and your Bang & Olufsen Product is applicable for online return, please make your claim at: <https://www.bang-olufsen.com/support> If the online return tool is not available in your country or if the Bang & Olufsen Product is not applicable for the tool, please contact the legal entity stated on the original invoice for the Bang & Olufsen Product.

Coverage

Bang & Olufsen warrants that the Bang & Olufsen Product is free from defects in material and workmanship under normal use and service for the Warranty Period. Bang & Olufsen Products are products of superior design and craftsmanship and should be treated with care. Procedures and suggestions on proper use and maintenance of Bang & Olufsen Products and its internal components should always be followed. Thus, this Warranty is conditioned upon proper use of the Bang & Olufsen Product within the Warranty Period. The Warranty does not cover:

PL Produkt B&O wprowadzane do obrotu przez B&O PLAY A/S! Zakupione od upoważnionego sprzedawcy są objęte ograniczoną gwarancją. Szczegółowe informacje dotyczącej zakresu oraz czasu trwania ograniczonej gwarancji znajdzie się na stronie www.bang-olufsen.com/limited-warranty.

PT Os produtos B&O comercializados pela B&O PLAY A/S e comprados a um revendedor autorizado estão abrangidos por uma garantia limitada. Para obter informações detalhadas sobre a cobertura desta garantia limitada e a sua duração visite www.bang-olufsen.com/limited-warranty.

PT-BR Os produtos da B&O são comercializados pela B&O PLAY A/S e podem ser comprados de um revendedor autorizado e são cobertos por garantia limitada. Para obter informações detalhadas sobre a cobertura desta garantia limitada e sua duração visite www.bang-olufsen.com/limited-warranty.

RU На продукцию B&O, включая акустические системы B&O PLAY A/S, покупаемые у авторизованного предприятия розничной торговли, распространяется действие ограниченной гарантии. Для получения более подробной информации относительно покрытия данной ограниченной гарантии и ее ограничениям срок действия перейдите на www.bang-olufsen.com/limited-warranty.

IT I prodotti B&O commercializzati da B&O PLAY A/S e acquistati da un rivenditore autorizzato sono coperti da garanzia limitata. Per informazioni più dettagliate relative alla copertura di questa garanzia limitata e alla sua durata, visitare il sito www.bang-olufsen.com/limited-warranty.

JA B&O PLAY A/Sが市販しているB&O製品を認定販売店から購入された場合、製品は限定保証の対象となります。製品保証（制限つき）の保証対象および保証期間についての詳細はこちらからご覧ください www.bang-olufsen.com/limited-warranty。

KO B&O PLAY A/S가 표기되어 있고 공인 판매점에서 구매한 B&O 제품은 제한 보증이 적용됩니다. 제품 보증 범위와 보증 기간에 대한 자세한 내용은 www.bang-olufsen.com/limited-warranty를 참조하십시오.

MA Produk B&O yang dipasarkan oleh B&O PLAY A/S dan dibeli daripada percantik sah adalah dilindungi oleh waranti yang terhad. Untuk butiran lanjut tentang perlindungan jaminan terhad ini dan tempoh terhadnya sila layari www.bang-olufsen.com/limited-warranty.

NL B & O-producten die op de markt worden gebracht door B&O PLAY A/S en worden gekocht bij een erkende verkoper, vallen onder de beperkte garantie. Voor meer informatie over deze beperkte garantie en de beperkte duur ervan, kunt u terecht op www.bang-olufsen.com/limited-warranty.

ES

Los productos B&O lanzados al mercado por B&O PLAY A/S como tales y adquiridos de un distribuidor autorizado están cubiertos por una garantía limitada. Si desea obtener información detallada acerca de la cobertura que proporciona esta garantía limitada y su duración, también limitada, visite www.bang-olufsen.com/limited-warranty.

FI

B&O PLAY A/S -yhtiön markkinoimat ja valtuutetulta jälleenmyyjältä ostetut tuotteet ovat rajoitetun takuun kattamia. Lisätietoja rajoitetun takuun soveltamisalasta ja rajoitetusta kestästä on osoitteessa www.bang-olufsen.com/limited-warranty.

FR

Les produits B&O commercialisés par B&O PLAY A/S et achetés auprès d'un revendeur agréé sont couverts par une garantie limitée. Pour de plus amples informations sur la couverture qu'apporte cette garantie limitée et sur sa durée, rendez-vous à l'adresse www.bang-olufsen.com/limited-warranty.

HE

תאגיד B&O מפרסם B&O PLAY תאגיד מפרסם B&O תאגיד, והוא מפרסם את המוצרים של B&O תאגיד לשימוש ביתי, והוא מפרסם את המוצרים של B&O תאגיד לשימוש ביתי. את המידע והפרטים לגבי אחריות B&O תאגיד, גם לגבי המוצרים של B&O תאגיד, ניתן למצוא בכתובת www.bang-olufsen.com/limited-warranty.

HU

A B&O PLAY A/S által hirdetett és hivatalos viszonteladótól megvásárolt B&O termékekre korlátozott garancia érvényes. Ezen korlátozott jótállás részleteit és időtartamát lásd a következő weboldalon: www.bang-olufsen.com/limited-warranty.

AR

منتجات B&O التي تقوم بتصنيعها B&O PLAY ويتم توزيعها من خلال مستخدمينا الموزعين في جميع أنحاء العالم إلى جميع الدول على مستوى العالم في منطقة الشرق الأوسط والهند وجنوب أوروبا، يرجى الاتصال بأي مستخدمينا B&O الذي يقوم بتصنيعها www.bang-olufsen.com/limited-warranty

DA

B&O-produkter, der markedsføres af B&O PLAY A/S og købes hos en autoriseret forhandler, er dækket af en begrænset garanti. Detaljerede oplysninger om denne begrænsede garanti og garantiens varighed findes på www.bang-olufsen.com/limited-warranty.

DE

Für B&O Produkte, die von B&O PLAY A/S vertrieben und von einem autorisierten Händler erworben wurden, gilt die beschriebene Garantie. Weitere Informationen zu den Garantiebestimmungen finden Sie unter www.bang-olufsen.com/limited-warranty.

EL

τα προϊόντα B&O που προωθούνται από την B&O PLAY A/S και τα οποία εγχύονται από εξουσιοδοτημένο κατάστημα λιανικής καλύπτονται από περιορισμένη εγγύηση. Για λεπτομέρειες πληροφορίες σχετικά με την κάλυψη αυτής της περιορισμένης εγγύησης και την περιορισμένη διάρκεια της προστασίας τη διεύθυνση www.bang-olufsen.com/limited-warranty.

EN

B&O products marketed by B&O PLAY A/S and purchased from an authorised retailer are covered by limited warranty. For detailed information on the coverage of this limited warranty and its limited duration go to www.bang-olufsen.com/limited-warranty.

جواز محدود
Beschränket Garantii
Limited Warranty
Περιορισμένη Εγγύηση
Garantia Limitada
Rajotteitu Takuu
Garantie Limitée
гарантия ограниченная
Korlatozott Jótállás
Garanzia Limitata
製品保証 (制限つき)
제품 보증
JamINAN Terhad
Bepertkte Garantie
Ograniczona Gwarancja
Garantia Limitada
ОграниченнаЯ Гарантия
Begränsad Garantii
Garantia Limitada
Sınırlı Garantii
有限保修
有限保固

SV

En IP67-klassificering avser skydd mot inträngning av damm och effekterna av en tillfällig nedsänkning i vatten. Kapaciteten för vattentätning kan minska över tiden och påverkas av produkten för saltvatten, joniserat vatten eller tvålatten. Notera att IP67 ger en beskrivning av produktens förmåga att skydda mot inträngning av vatten eller fasta ämnen in i produktens inre strukturer och som följaktligen komprometterar normal drift, men anger inte att produktens utseende som också är skyddat.

ZH

IP67 防护等级表示产品的防护能力，涉及产品防止灰尘进入和产品避免暂时浸入水中的影响的能力。防水能力可能会随着时间的推移而减弱，如果产品坠落或受到冲击，防水能力也可受到影响。产品不得接触盐水、离子水或皂液。请注意，IP67 防护等级描述的产品防护能力是指产品防止水或固体颗粒进入内部结构、避免影响产品正常操作的能力，并不说明产品外观也得

ZHTW

IP67 等級與可避免灰塵進入和可暫時浸泡於水中的影響有關。防水能力可能會隨著時間而減弱，若產品掉落或受到撞擊也可能會有所影響。切勿將產品浸在鹽水、電離水或肥皂水中。請注意，IP67 描述的是產品具備防止水或固體滲入產品內部結構，以及隨後損害其正常運作的能力，但並未說明也能保護產品的外觀。

AR

برتبط تصنيف IP67 بالحماية ضد دخول الغبار والتآكل في الأماكن الرطبة من الماء. قد تتأثر جودة الحماية ضد الماء مع مرور الوقت ويمكن أن تتأثر إذا سقط المنتج أو ارتطبت. لا تعترض المنتج قدرات مقاومة الماء أو الماء المقطر أو الماء والصابون. يرجى ملاحظة أن تصنيف IP67 يصف قدرات الحماية للمياه العذبة أو الماء المقطر أو الماء أو المواد الصلبة في الهياكل الداخلية للمنتج ومن ثم يخلو المنتج من أي حماية للمنتج على الوتيرة من قضا الماء أو المواد الصلبة في الهيكل الداخلي للمنتج. بالمقابل العازل المائي ولا يمكن أن يحدد أي مظهر المنتج محمي أيضًا.

afnemen en wanneer het apparaat aan sterke schokken wordt blootgesteld. Voorkom dat het apparaat in contact komt met zout water, geïoniseerd water of zeewater. Let op: IP67 beschrijft het vermogen van het product om beschermen te bieden tegen binnendringing van water of vaste stoffen en daardoor afbreuk te doen aan de normale werking, maar het specificeert niet dat de buitenkant van het product ook wordt beschermd.

A classificação IP67 está relacionada com a protecção contra entrada de pó e os efeitos de imersão temporária em água. A capacidade de impermeabilidade pode diminuir com o tempo e pode ser afetada se o produto sofrer uma queda ou impacto. Não exponha o produto a água salgada, ionizada ou com sabão. Tenha em atenção que a classificação IP67 descreve a capacidade de impermeabilização do produto contra entrada de água ou sólidos na estrutura interna do produto e, por conseguinte, põe em causa o funcionamento normal, mas não específica se o aspeto do produto também está protegido.

PT

Стенная защита IP67 относится к защите от проникновения пыли и последствий временного погружения в воду. Водонепроницаемость может со временем уменьшиться и может быть нарушена, если устройство упадет или получит удар. Не подверяйте устройство воздействию соленой, ионизированной или мыльной воды. Обратите внимание, что соответствие стандарту IP67 указывается на способность устройства противостоять проникновению воды или твердых частиц внутрь устройства и, следовательно, нарушению его нормальной работы, но не указывает на то, что внешний вид устройства не изменится.

RU

IT La certificazione IP67 si riferisce alla protezione dall'ingresso di polvere e dagli effetti dell'immersione temporanea in acqua. Le capacità di resistenza all'acqua possono diminuire con il tempo e risentire di eventuali cadute o urti subiti dal prodotto. Non esporre il prodotto ad acqua salata, acqua ionizzata o saponata. IP67 indica la capacità del prodotto di difendersi dalla penetrazione di acqua o solidi nelle strutture interne del prodotto stesso con conseguente compromissione del normale funzionamento. Tuttavia, ciò non implica che anche l'aspetto del prodotto venga protetto.

JA IP67格は、粉塵の侵入および一時的な水没に対する保護を示しています。防水機能は時間の経過に伴って低下する可能性があります。また製品が落下したり衝撃を受けたりすることによっても影響を受ける場合があります。製品を塩水や汽水、石鹸水等に曝さないようにしてください。IP67は製品内部への水や固形物の侵入を防ぎ、その後の動作を正常に保つ能力を示しています。ただし、製品の外觀が同様に保護されることは保証していません。

KO IP67 등급은 먼지 침투와 물 속에서 일시적인 부상 효과와 관련된 것입니다. IP67 등급은 시간 경과와 함께 열화를 수 있으며 제품을 떨어뜨리거나 충격이 가해질 경우 영장이 있을 수 있습니다. 제품을 소금물, 이온화된 물 또는 비눗물에 노출시키지 마십시오. IP67은 제품의 물 또는 고염물에서 물내부 구조 침투나 그로 인한 정상적인 작동 성능을 방지하는 성능에 대해 시험하고 있으나, 제품의 외관이 완전히 보호되는 것을 의미하지 않습니다.

NL Een IP67-classificatie heeft betrekking op bescherming tegen binnendringen van stof en de effecten van tijdelijke onderdompeling in water. Waterdichtheid kan na verloop van tijd

des Geräts bezieht, das Eindringen von Wasser oder Feststoffen in das Innere des Geräts und die darauf folgende Beeinträchtigung des normalen Betriebs zu verhindern, aber keine Aussage darüber umfasst, ob das Aussehen des Geräts auch geschützt ist.

ES

Una clasificación IP67 se refiere a la protección contra la entrada de polvo y los efectos de la inmersión temporal en agua. Las capacidades de resistencia al agua pueden disminuir con el tiempo y pueden verse afectadas si el producto se cae o recibe un impacto. No exponga el dispositivo a agua salada, agua ionizada o agua jabonosa. Tenga en cuenta que el grado de protección IP67 describe la capacidad del producto como escudo contra la penetración de agua o partículas sólidas en sus estructuras internas y, posteriormente, afectar al funcionamiento normal, pero no específica que la apariencia del producto también esté protegida.

FR

Une classification IP67 concerne la protection contre la pénétration de poussière et les effets de l'immersion temporaire dans l'eau. Les capacités d'étanchéité peuvent diminuer avec le temps et peuvent être affectées si le produit tombe ou reçoit un impact. N'exposez pas le produit à l'eau salée, à l'eau ionisée ou à l'eau savonneuse. Veuillez noter que IP67 décrit la capacité du produit à se protéger contre la pénétration d'eau ou de solide dans les structures internes du produit et, par la suite, l'endommagement au fonctionnement normal, mais ne spécifie pas que l'apparence du produit est également sous protection.

EN An IP67 rating relates to protection against dust ingress and the effects of temporary immersion in water. Waterproof capabilities may diminish over time and can be impacted if the product is dropped or receives an impact. Do not expose the product to salt water, ionized water or soapy water. Please note that IP67 describes the product's ability to shield against generation of water or solids into the product's inner structures and subsequently compromising normal operation but does not specify that the product's appearance is protected as well.

DA En IP67-klassificering forholder sig til beskyttelse mod vandtætte kvalifikationer og af midlertidig nedseenkning i vand. Vandtætte kvalifikationer kan reduceres med tiden, og kan være påvirket, hvis produktet tabes eller bliver påvirket. Udseet ikke produktet for saltvand, ioniseret vand eller sæbevand. Bemærk, at IP67 beskriver produktets evne til at beskytte sig mod gennemtrængning af vand eller faste stoffer, i produktets indre struktur. Hvor den efterfølgende kompromitterer normal drift, men specifikere ikke at produktets udseende også er beskyttet.

DE Die Klassifizierung IP67 bezieht sich auf den Schutz gegen das Eindringen von Staub und dem kurzzeitigen Eintauchen in Wasser. Die Wasserdichtheit kann sich im Verlauf der Zeit reduzieren und kann beeinträchtigt sein, wenn das Gerät heruntergefallen ist oder einen Stoß erhalten hat. Setzen Sie das Gerät nicht Salzwasser, ionisiertem oder Seifenwasser aus. Bitte beachten Sie, dass die Klassifizierung IP67 sich auf die Fähigkeit

Voice assistant operation requires a Bluetooth connection from a mobile phone.

Use of the Made for Apple badge means that an accessory has been designed to connect specifically to the Apple product(s) identified in the badge and has been certified by the developer to meet Apple performance standards. Apple is not responsible for the operation of this device or its compliance with safety and regulatory standards.

進口商：遠寬電信股份有限公司
地址：新北市新店區安興路127號10樓
電話：02-86660168

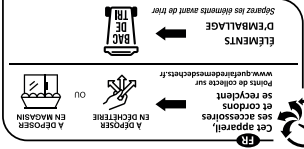

限用物質含有情況標示聲明書

Declaration of the Presence Condition of the Restricted Substances Marking

設備名稱：藍牙音響 型號(型式)：Beosound A1 2nd Gen Type designation (Type)		限用物質及其化學符號 Restricted substances and its chemical symbols						單位 Unit
鉛 Lead (Pb)	汞 Mercury (Hg)	鎘 Cadmium (Cd)	六價鉻 Hexavalent chromium (Cr ⁶⁺)	多溴聯苯 Polybrominated biphenyls (PBB)	多溴二苯醚 Polybrominated diphenyl ethers (PBDE)	附件	○	
○	○	○	○	○	○	印刷線路板	○	
○	○	○	○	○	○	電線	○	
○	○	○	○	○	○	擴音裝置	○	
○	○	○	○	○	○	附件	○	

Note 1: "Exceeding 0.1 wt %" and "exceeding 0.01 wt %" indicate that the percentage content of the restricted substance exceeds the reference percentage value of presence condition.
 Note 2: "○" 係指該項限用物質之百分比含量未超出百分比含量基準。
 Note 3: "○" indicates that the percentage content of the restricted substance does not exceed the percentage of reference value of presence.
 備考3: "○" 係指該項限用物質為排除項目。
 Note 3: The "-" indicates that the restricted substance corresponds to the exemption.



以下規範供臺灣市場使用...
The following specifications are for Taiwanese market usage ...

額定值:	DC 5V 3A
耗電功率:	15W
尺寸:	直徑 133mm

“本產品符合低功率電波輻射性電機管理辦法:

第十二條

經型式認證合格之低功率射頻電機，非經許可，公司、商號或使用者均不得擅自變更頻率、加大功率或變更原設計之特性及功能。

第十四條

低功率射頻電機之使用不得影響飛航安全及干擾合法通信；經發現有干擾現象時，應立即停用，並改善至無干擾時方得繼續使用。

前項合法通信，指依電信規定作業之無線電信。低功率射頻電機須忍受合法通信或工業、科學及醫療用電波輻射性電機設備之干擾。

最大環境溫度不應超過40°C。

重要安全说明

- 请阅读这些说明。
- 请保留这些说明。
- 请注意所有警告。
- 请遵守所有说明。
- 只能用于干净清洁。
- 请勿堵塞任何通风孔。请根据制造商的说明进行安装。
- 请勿安装在散热器、热风调节器、火炉或其他发热设备（包括放大器）等热源附近。
- 不要忽略极性插头的安全作用。极性插头有两个插片，其中一个比另一个宽。如果提供的插头无法插入您的插座，请咨询电工了解有关更换旧插座事宜。
- 保护电源线不被踩踏或挤压，特别是在插头、电源插座和电源线从设备延伸出来的位置。
- 仅使用制造商指定的或随设备销售的推车、支架、三脚架、托架或台桌。如果使用推车，请在移动推车/设备组合时务必小心，以免由于翻倒而造成伤害。
- 在雷雨天气或长时间不使用时，应拔出此设备的插头。
- 有关维修事宜应委托给有资质的维修服务人员。当设备遭到损坏（如电源线或插头损坏、液体进入或物体掉入设备、设备被雨淋湿或受潮、无法正操作或者跌落）时，必须进行维修。
- 最大环境温度不应超过40°C。
- 警告：电源插头或设备耦合器作为断开装置，应保持随时可用。
- 消费者若使用电源适配器供电，则应购买配备使用获得CCC认证并满足标准要求电源适配器。

简体中文

Beosound A1 2nd Gen

产品中有毒有害物质或元素名称及含量



部件名称：	铅 (Pb)	汞 (Hg)	镉 (Cd)	六价铬 (Cr[VI])	多溴联苯 (PBB)	多溴二苯醚 (PBDE)
	产品中有毒物质的名称及含量					
电路板	×	○	○	○	○	○
喇叭	○	○	○	○	○	○
线材	×	○	○	○	○	○
附件	×	○	○	○	○	○
电池组	×	○	○	○	○	○
箱体	○	○	○	○	○	○
铝网	×	○	○	○	○	○

本表格依据 SJ/T 11364 的规定编制

○ 表示该有害物质在该部件所有均质材料中的含量均在 GB/T 26572 规定的限量要求以下。

× 表示该有害物质至少在该部件的某一均质材料中的含量超出 GB/T 26572 规定的限量要求。

- Deixe espaço suficiente em torno do produto para possibilitar uma ventilação adequada.
- Não tente abrir o produto. Essas operações devem ser efetuadas por pessoal de assistência técnica qualificado.



Equipamentos elétricos e eletrônicos, peças e pilhas/baterias assinalados com este símbolo não devem ser eliminados juntamente com resíduos domésticos normais, mas sim recolhidos e eliminados separadamente para proteger o meio ambiente.

O revendedor da Bang & Olufsen dar-lhe-á informações sobre a forma correta de eliminar esses resíduos no seu país.

Para evitar o risco de choque elétrico, não ligue o produto à fonte de alimentação elétrica com a grelha removida.



Importante!

- Evite colocar o produto sob luz solar direta ou luz artificial direta (por exemplo, um holofote).
- Certifique-se de que o produto seja instalado, posicionado e ligado em conformidade com as instruções.
- Não coloque quaisquer objetos sobre o produto.
- A temperatura ambiente máxima não deve ultrapassar os 40 °C.
- AVISO: Não deve colocar fontes de chamas desprotegidas (por exemplo, velas acesas) sobre o produto.
- Não sujeite o produto a humidade elevada, chuva ou fontes de calor. O produto destina-se apenas a utilização no interior e em ambientes secos e domésticos (não aplicável a produtos portáteis).

Pelo presente, a Bang & Olufsen A/S declara que o tipo de equipamento de rádio Beosound A1 2nd Gen está em conformidade com a Diretiva 2014/53/UE. A Declaração de Conformidade total pode ser encontrada no site Web seguinte: on.beo.com/beosound-A1-support

Em conformidade com 2014/53/UE, Diretiva relativa aos equipamentos de rádio (RED)
De acordo com o Artigo 10.8(a) e 10.8(b) da RED, a tabela seguinte fornece informações sobre bandas de frequência utilizadas e a potência de transmissão RF máxima do produto para venda na UE:

Intervalo de frequência (MHz)	2402-2480MHz
Potência máx. de transmissão (dBm)	≤10 dBm

O firmware do produto está disponível para transferir a partir da Bang & Olufsen App.
O produto vai ser vendido em todos os membros da União Europeia e países EFTA.

- Lasciare spazio sufficiente intorno al prodotto per consentirne una ventilazione adeguata.
- Non tentare di aprire il prodotto. Queste operazioni sono esclusivamente di competenza del personale tecnico qualificato.



Apparecchiature elettriche ed elettroniche, parti e batterie, contrassegnate con questo simbolo non devono essere smaltite con i normali rifiuti domestici, ma devono essere raccolte e smaltite separatamente per proteggere l'ambiente.

Per informazioni sulla procedura di smaltimento corretta per il proprio Paese, rivolgersi a un rivenditore Bang & Olufsen.

Per prevenire il rischio di scosse elettriche, non collegare alla rete elettrica con la griglia rimossa.



Importante!

- Non esporre il prodotto alla luce del sole o artificiale (ad esempio un faretto) diretta.
- Verificare che il prodotto sia stato installato, posizionato e collegato in conformità con le istruzioni fornite.
- Non posare oggetti sopra il prodotto.
- La temperatura ambiente massima non deve essere superiore a 40°C.
- AVVERTENZA: Non collocare sorgenti di fiamme libere, ad esempio candele accese, sul prodotto.
- Non esporre il prodotto a valori elevati di umidità, a pioggia o a fonti di calore.
- Il prodotto è destinato a essere utilizzato esclusivamente in ambienti interni, asciutti e domestici (non applicabile ai prodotti portatili).

Con la presente Bang & Olufsen A/S dichiara che l'apparecchiatura radio di tipo Beosound A1 2nd Gen è conforme alla Direttiva 2014/53/UE. Il testo completo della Dichiarazione di conformità è reperibile al seguente sito web:
on.beo.com/beosound-A1-support

Conformità con la Direttiva 2014/53/UE (RED)
Ai sensi degli articoli 10.8(a) e 10.8(b) della Direttiva RED, la seguente tabella fornisce informazioni sulle bande di frequenza utilizzate e sulla potenza massima di trasmissione in radiofrequenza dei prodotti in vendita nell'UE:

Gamma di frequenza (MHz)	2402-2480MHz
Potenza massima di trasmissione (dBm)	≤10 dBm

Il firmware del prodotto è scaricabile dall'app Bang & Olufsen. Il presente prodotto viene venduto in tutti i Paesi membri dell'Unione Europea e AELS.

- Mantenga el espacio necesario alrededor del equipo para favorecer su correcta ventilación.
- No intente abrir el equipo. Este tipo de operaciones debe ser realizado por personal técnico cualificado.



Los equipos, piezas y baterías de tipo eléctrico y electrónico marcados con este símbolo no deben eliminarse junto con los residuos domésticos habituales; en su lugar, deben ser recogidos y eliminados de forma independiente para proteger el medioambiente. Su distribuidor de Bang & Olufsen le asesorará acerca de los pasos a seguir en su país para realizar la eliminación de forma correcta.

CAUTION  A fin de evitar posibles descargas eléctricas, no conecte el equipo a la red eléctrica si la rejilla no está instalada.

Importante

- Evite colocar el equipo en un lugar expuesto a la luz solar directa o a luz artificial directa, como la generada por un foco halógeno.
- Asegúrese de que el equipo permanezca instalado, situado y conectado de acuerdo con las instrucciones.
- No coloque ningún objeto sobre el equipo.
- La temperatura ambiental máxima no debe superar los 40°C.
- **ADVERTENCIA:** No deben colocarse fuentes de llama viva, como velas encendidas, encima del producto.
- No someta el equipo a niveles elevados de humedad, a la lluvia o a fuentes de calor.
- El producto está destinado al uso en interiores domésticos sin humedades (no se aplica a los productos portátiles).



Por la presente, Bang & Olufsen A/S declara que el tipo de equipo de radio Beosound A1 2nd Gen cumple la directiva 2014/53/EU. Se puede consultar la declaración de conformidad completa en el sitio web siguiente: on.beo.com/beosound-A1-support

Conformidad con la directiva 2014/53/EU sobre la comercialización de equipos radioeléctricos (RED)
Conforme a los artículos 10.8(a) y 10.8(b) de la RED, la tabla siguiente proporciona información sobre las bandas de frecuencias utilizadas y la potencia de RF transmitida máxima del producto a la venta en la UE.

Intervalo de frecuencias (MHz)	2402-2480MHz
Potencia transmitida máxima (dBm)	≤10 dBm

El firmware del producto está disponible para descargar desde la Bang & Olufsen App.
El producto a la venta en todos los países miembros de la Unión Europea y de la EFTA.

- Laisser suffisamment d'espace autour de l'appareil pour une ventilation appropriée.
- Ne pas tenter d'ouvrir le boîtier de l'appareil. Les opérations de ce type doivent être confiées à du personnel de maintenance qualifié.



Il n'est pas permis de jeter les équipements, les pièces électriques et électroniques et les batteries portant ce symbole avec les ordures ménagères ; ces équipements doivent être collectés et mis au rebut séparément afin de préserver l'environnement.

Votre revendeur Bang & Olufsen se fera un plaisir de vous conseiller sur la procédure correcte de mise au rebut dans votre pays.

Afin d'écartier tout danger d'électrocution, ne branchez pas l'appareil au secteur lorsque la grille est ôtée.



Important !

- Eviter d'exposer directement l'appareil au soleil ou à la lumière artificielle (spots, etc.).
- Vérifier que l'appareil est installé, positionné et connecté conformément aux instructions.
- Ne poser aucun objet sur l'appareil.
- La température ambiante maximale ne doit pas dépasser 40°C.
- **AVERTISSEMENT:** Aucune source de flamme nue, telle que des bougies allumées, ne doit être placée sur l'appareil.
- Ne pas exposer l'appareil à un taux d'humidité élevé, à la pluie ou à une source de chaleur.
- Le produit est destiné à un usage intérieur dans un environnement domestique sec uniquement (non applicable aux produits portables).

Par la présente, Bang & Olufsen A/S déclare que l'équipement radio de type Beosound A1 2nd Gen est conforme à la directive 2014/53/EU. La Déclaration de Conformité complète se trouve sur le site Web suivant : on.beo.com/beosound-A1-support

Conformité à la directive sur les équipements radio 2014/53/EU (RED) conformément à l'article 10.8(a) et 10.8(b) de RED, le tableau suivant fournit des informations sur les bandes de fréquences utilisées et la puissance de transmission RF maximale du produit à vendre dans l'UE :

Gamme de fréquences (MHz)	2402-2480MHZ
Puissance de transmission max. (dBm)	≤10 dBm

Le firmware du produit est disponible pour téléchargement à partir de Bang & Olufsen App.
Le produit à vendre dans tous les pays membres de l'Union européenne et de l'AELE.

- Lassen Sie um das Gerät stets genug Platz für ausreichende Lüftung.
- Versuchen Sie nicht, das Gerät zu öffnen. Überlassen Sie dies qualifiziertem Servicepersonal.

Deutsch (German)

Mit diesem Symbol gekennzeichnete elektrische und elektronische Geräte, Bauteile und Batterien dürfen nicht in den normalen Haushaltsmüll gegeben, sondern müssen zum Schutz der Umwelt sämlich getrennt eingesammelt und entsorgt werden.



Ihr Bang & Olufsen Fachhändler berät Sie bei der sachgerechten Entsorgung in Ihrem Land.

Schließen Sie das Gerät nicht an das Netz an, wenn die Abdeckung entfernt ist, um eine Stromschlaggefahr zu vermeiden.



Wichtiger Hinweis:

- Stellen Sie das Gerät nicht in direktem Sonnenlicht oder nahe an direkten künstlichen Lichtquellen wie Spots auf.
- Achten Sie darauf, dass das Gerät entsprechend diesen Hinweisen platziert, angeschlossen und eingestellt wird.
- Stellen Sie keine Gegenstände auf das Gerät.
- Die max. Umgebungstemperatur darf 40°C nicht überschreiten.
- ACHTUNG: Es dürfen keine offenen Flammen, wie brennende Kerzen auf das Produkt gestellt werden.
- Setzen Sie das Gerät nicht hoher Feuchtigkeit, Regen und Wärmequellen aus.
- Das Produkt ist nur für den Innenbereich in trockenen, häuslichen Umgebungen bestimmt (gilt nicht für tragbare Produkte).

Hiermit erklärt Bang & Olufsen A/S, dass das Radiogerät vom Typ Beosound A1 2nd Gen die Richtlinie 2014/53/EU erfüllt. Die vollständige Konformitätserklärung ist auf der folgenden Webseite erhältlich:
on.beo.com/beosound-A1-support

Erfüllt die Funkgeräte Richtlinie 2014/53/EU (RED) in Übereinstimmung mit Artikel 10.8(a) und 10.8(b) der RED bietet die folgende Tabelle Informationen zu den verwendeten Frequenzbändern und zur maximalen Funkfrequenz-Sendeleistung des Produkts, das in der EU vertrieben wird:

Frequenzbereich (MHz)	Max. Sendeleistung (dBm)
2402-2480MHz	≤10 dBm

Die Produkt-Firmware steht über die Bang & Olufsen App zum Download bereit.

Das Produkt wird in allen Mitgliedsstaaten der Europäischen Union und in den EFTA-Staaten vertrieben.

Dansk (Danish)

Elektrisk og elektronisk udstyr, reservedele og batterier, sammen med almindeligt husholdningsaffald. Det skal indsamles og bortskaffes separat for at beskytte miljøet. Din Bang & Olufsen forhandler kan rådgive dig om den korrekte bortskaffelsesmetode i dit land.

Undlad at slutte produktet til lysnettet, mens gitteret er fjernet, da dette indebærer risiko for elektrisk stød.

CAUTION



Vigtigt!

- Anbring ikke produktet i direkte sollys eller direkte under kunstig belysning, f.eks. en spot.
- Sørg for, at produktet sættes op, placeres og tilsluttes i overensstemmelse med instruktionerne.
- Anbring ikke genstande oven på produktet.
- Den maksimale omgivelsestemperatur bør ikke overstige 40°C.
- ADVARSEL: Ingen blottede flammekilder såsom tændte stearinlys må placeres på produktet.
- Udsæt ikke produktet for høj luftfugtighed, regn eller varme.
- Produktet er beregnet til indendørs brug i tørre, hjemlige omgivelser (gælder ikke for bærbare produkter).
- Sørg for, at der er plads nok omkring produktet til at sikre tilstrækkelig ventilation.
- Forsøg aldrig at åbne produktet. Produktet må kun åbnes af uddannede serviceteknikere.

Bang & Olufsen A/S erklærer hermed, at radioudstyret
type Beosound A1 2nd Gen er i overensstemmelse
med direktiv 2014/53/EU. Den fuldstændige
overensstemmelseserklæring fremgår af følgende
side: on.beo.com/beosound-A1-support

I overensstemmelse med radioudstyrsdirektivet 2014/53/EU (RED)
i overensstemmelse med paragraf 10.8(a) og 10.8(b) tilhørende
RED - følgende tabel indeholder oplysninger om de benyttede
frekvensområder og den maksimale RF-sendeeffekt for produktet, når
det sælges i EU:

Frekvensområde (MHz)	2.402-2.480MHz
Maks. sendeeffekt (dBm)	≤10 dBm

Produktets firmware er tilgængeligt til download fra www.bang-olufsen.com &
Olufsen.

Produktet markedsføres til salg i alle EU-medlemsstater og EFTA-lande.

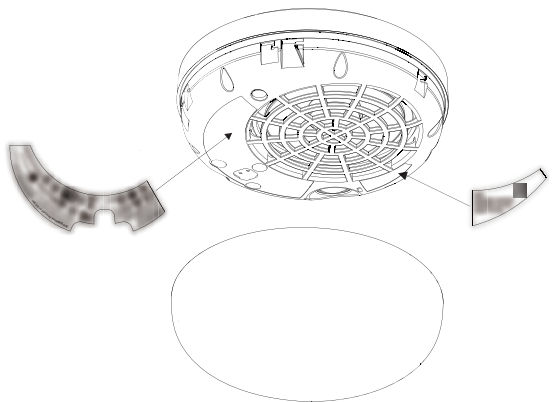

RSS-102 statement

- English:
This equipment complies with Industry Canada radiation exposure limits set forth for an uncontrolled environment.
- French:
Cet équipement est conforme à l'exposition aux rayonnements Industry Canada limites établies pour un environnement non contrôlé.

Model: Beosound A1 2nd Gen

Product Name: Bluetooth Speaker

Bang & Olufsen A/S

Phone number: +45 96841122

www.bang-olufsen.com

- Connect the equipment into an outlet on a circuit different from that to which the receiver is connected.
 - Consult the dealer or an experienced radio/TV technician for help.
- RF warning statement:**
- The device has been evaluated to meet general RF exposure requirement. The device can be used in portable exposure condition without restriction.

**CAN ICES-3 (B)/NMB-3(B)
IC warning**

- English:
This device contains licence-exempt transmitter(s)/receiver(s) that comply with Innovation, Science and Economic Development Canada's licence-exempt RSS(s). Operation is subject to the following two conditions:
a) this device may not cause interference, and
b) this device must accept any interference, including interference that may cause undesired operation of the device.

- French:
Cet appareil contient des émetteurs / récepteurs exempts de licence conformes aux RSS (RSS) d'Innovation, Sciences et Développement économique Canada. L'exploitation est autorisée aux deux conditions suivantes :
a) l'appareil ne doit pas produire de brouillage, et
b) l'utilisateur de l'appareil doit accepter tout brouillage radioélectrique subi, même si le brouillage est susceptible d'en compromettre le fonctionnement."

FCC Statement

- This device complies with Part 15 of the FCC Rules. Operation is subject to the following two conditions:
 - a) This device may not cause harmful interference, and
 - b) This device must accept any interference received, including interference that may cause undesired operation.
- Changes or modifications not expressly approved by the party responsible for compliance could void the user's authority to operate the equipment.

NOTE: This equipment has been tested and found to comply with the limits for a Class B digital device, pursuant to Part 15 of the FCC Rules. These limits are designed to provide reasonable protection against harmful interference in a residential installation.

This equipment generates uses and can radiate radio frequency energy and, if not installed and used in accordance with the instructions, may cause harmful interference to radio communications. However, there is no guarantee that interference will not occur in a particular installation. If this equipment does cause harmful interference to radio or television reception, which can be determined by turning the equipment off and on, the user is encouraged to try to correct the interference by one or more of the following measures:

- Reorient or relocate the receiving antenna.
- Increase the separation between the equipment and receiver.

Important!

- Avoid placing the product in direct sunlight or direct artificial light, such as a spotlight.
- Make sure that the product is set up, placed and connected in accordance with the instructions.
- Do not place any items on top of your product.
- The max ambient temperature should not exceed 40°C.
- WARNING: No naked flame sources, such as lighted candles should be placed on the product.
- Do not subject the product to high humidity, rain or sources of heat.
- The product is intended for indoor use in dry, domestic environments only (not applicable to portable products).
- Leave enough space around the product for adequate ventilation. Do not attempt to open the product. Leave such operations to qualified service personnel.

The product firmware is available for download from the Bang & Olufsen App.

The product to be sold in all European Union member and EFTA countries.

The product complies with the PSTI Act 2022 requirements.

Electrical and electronic equipment, parts and batteries marked with this symbol must not be disposed of with normal household waste, it must be collected and disposed of separately to protect the environment. Your Bang & Olufsen retailer will advise you of the correct way of disposal in your country.



To prevent electric shock hazard, do not connect to mains power supply while grille is removed.



Frequency range (MHz)	2402-2480MHz
Max. Transmit Power (dbm)	≤10 dbm

The lightning flash symbol within an equilateral triangle, is intended to alert the user to the presence of uninsulated "dangerous voltage" within the product's enclosure that may be of sufficient magnitude to constitute a risk of electric shock to persons.



The exclamation point within an equilateral triangle is intended to alert the user to the presence of important operating and maintenance (servicing) instructions in the literature accompanying the product.



Hereby, Bang & Olufsen A/S declares that the radio equipment type Beosound A1 2nd Gen is in compliance with Directive 2014/53/EU. The full Declaration of Conformity can be found at the following web site: on.beo.com/beosound-A1-support

Compliance with 2014/53/EU Radio Equipment Directive (RED) in accordance with Article 10.8(a) and 10.8(b) of the RED, the following table provides information on the frequency bands used and the maximum RF transmit power of the product for sale in the EU:

- Unplug this apparatus during lightning storms or when unused for long periods of time.
- Refer all servicing to qualified service personnel. Servicing is required when the apparatus has been damaged in any way, such as power-supply cord or plug is damaged, liquid has been spilled on or objects have fallen into the apparatus, the apparatus has been exposed to rain or moisture, does not operate normally, or has been dropped.
- **CAUTION:** Never replace the battery. Danger of explosion exists if battery is incorrectly replaced or non-equivalent type used.
- **WARNING:** The battery (battery or batteries or battery pack) shall not be exposed to excessive heat such as sunshine, fire or the like.
- Using USB-C chargers of poor quality may trigger false operations during charging.
- **WARNING:** To reduce the risk of fire or electric shock, do not expose this appliance to rain or moisture. Do not expose this equipment to dripping or splashing and ensure that no objects filled with liquids, such as vases, are placed on the equipment.

Important safety instructions

- Read these instructions.
- Keep these instructions.
- Heed all warnings.
- Follow all instructions.
- Clean only with dry cloth.
- Do not block any ventilation openings. Install in accordance with the manufacturer's instructions.
- Do not install near any heat sources such as radiators, heat registers, stoves, or other apparatus (including amplifiers) that produce heat.
- Do not defeat the safety purpose of the polarized plug. A polarized plug has two blades with one wider than the other. If the provided plug does not fit into your outlet, consult an electrician for replacement of the obsolete outlet.
- Protect the power cord from being walked on or pinched particularly at plugs, convenience receptacles, and the point where they exit from the apparatus.
- Only use attachments/accessories specified by the manufacturer. Use only with the cart, stand, tripod, bracket, or table specified by the manufacturer, or sold with the apparatus. When a cart is used, use caution when moving the cart/apparatus combination to avoid injury from tip-over.



Se yderligere oplysninger på:
Für weitere Informationen, siehe:
Για περισσότερες πληροφορίες, δείτε:
For additional information, see (link provides content with regulatory
conformance guidelines):
Si desea obtener más información, visite el sitio web:
Lisätietoja saat seuraavista osoitteista:
Pour plus d'informations, visitez (lien fournit du contenu aux directives
de conformité réglementaires):
Per ulteriori informazioni, vedete:
詳細については、次を参照ください:
Voor meer informatie, zie:
Para obter mais informações, consulte:
Дополнительную информацию см. по адресу:
Mer information finns på:
如需了解更多詳情, 請參見:
詳細資訊, 請參閱:
<https://www.bang-olufsen.com/support>

Viktig
Wichtiger Hinweis
Σημαντικό
Important
Important
Tärkeää
Important
Important
重要
중요
Belangrijk
Importante
Bismannet!
Viktig
注意
重要事項

3511531
Version 1.0
2001